

CAPITAL & BASE
 OPTIONAL
 ALL COLUMNS SHIPPED
 IN HALF-UNITS
 COLUMN WILL FIT UP TO:
 25" SQ. BEAM
 Ø35" COLUMN

CLS36

*FIBERGLASS
 TECHNOLOGIES, INC.*

1610 Hanford St., Levittown, PA * (215) 943-4567 * FAX (215) 943-4540

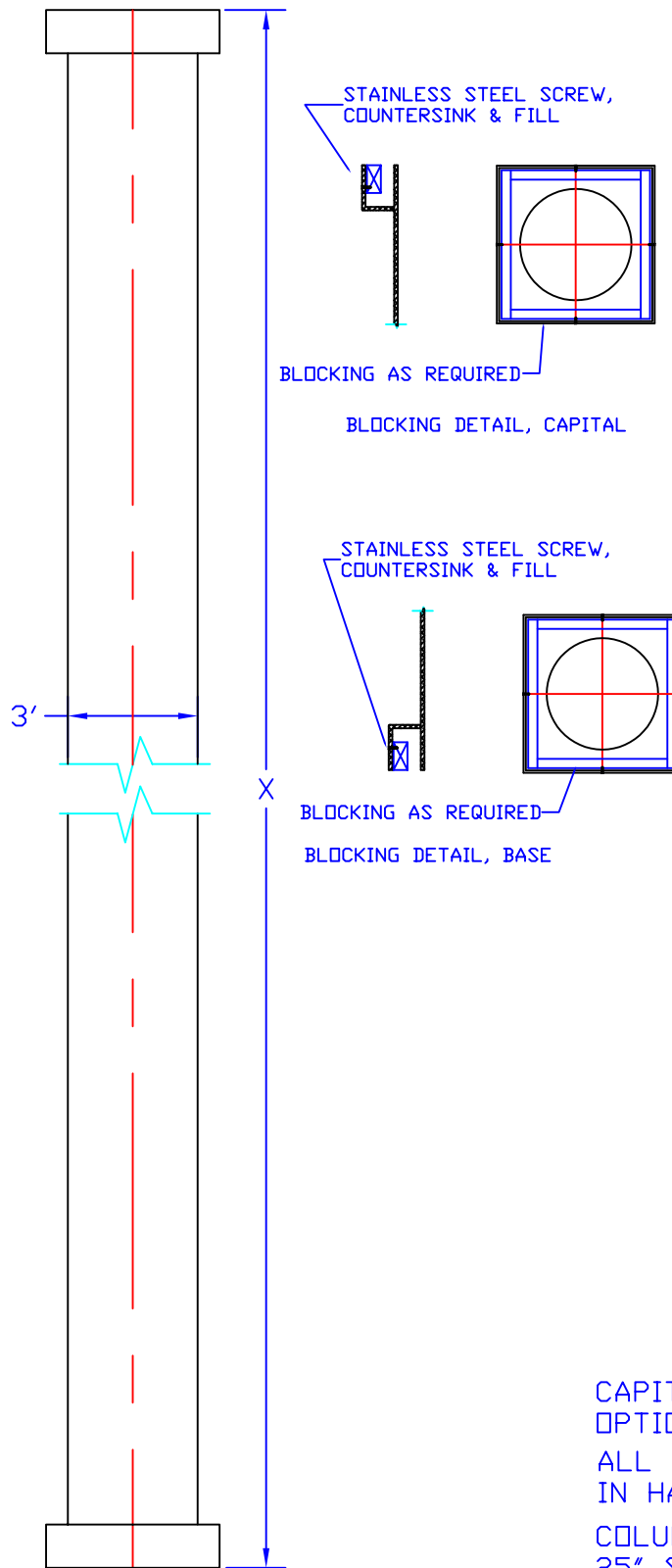

CAPITAL & BASE
OPTIONAL
ALL COLUMNS SHIPPED
IN HALF-UNITS
COLUMN WILL FIT UP TO:
25" SQ. BEAM
Ø35" COLUMN

CLS36A

*FIBERGLASS
TECHNOLOGIES, INC.*

1610 Hanford St., Levittown, PA * (215) 943-4567 * FAX (215) 943-4540

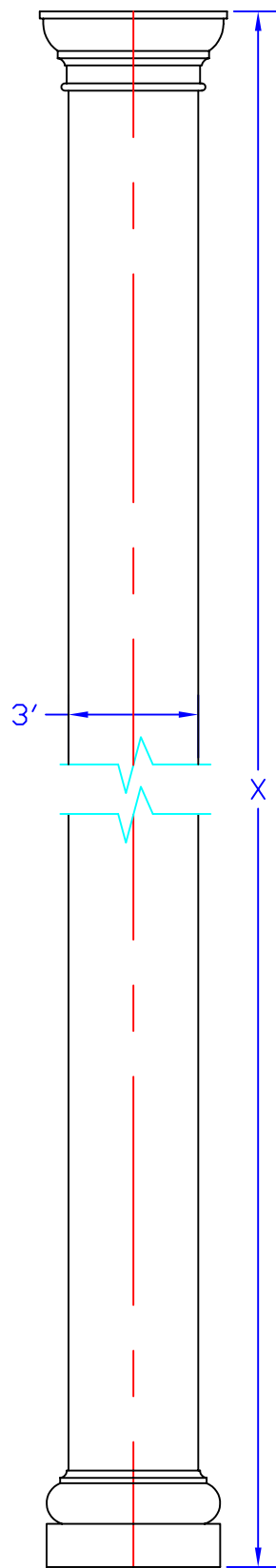

STAINLESS STEEL SCREW,
COUNTERSINK & FILL

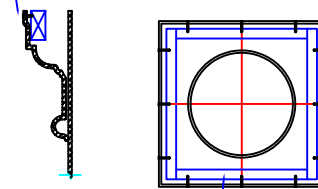

BLOCKING AS REQUIRED

BLOCKING DETAIL, CAPITAL

STAINLESS STEEL SCREW,
COUNTERSINK & FILL

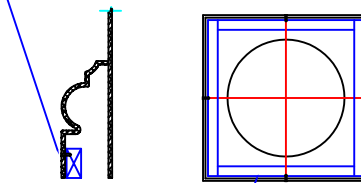

BLOCKING AS REQUIRED

BLOCKING DETAIL, BASE

CAPITAL & BASE
OPTIONAL

ALL COLUMNS SHIPPED
IN HALF-UNITS

COLUMN WILL FIT UP TO:
25" SQ. BEAM
Ø35" COLUMN

CLS36B

FIBERGLASS
TECHNOLOGIES, INC.

1610 Hanford St., Levittown, PA * (215) 943-4567 * FAX (215) 943-4540

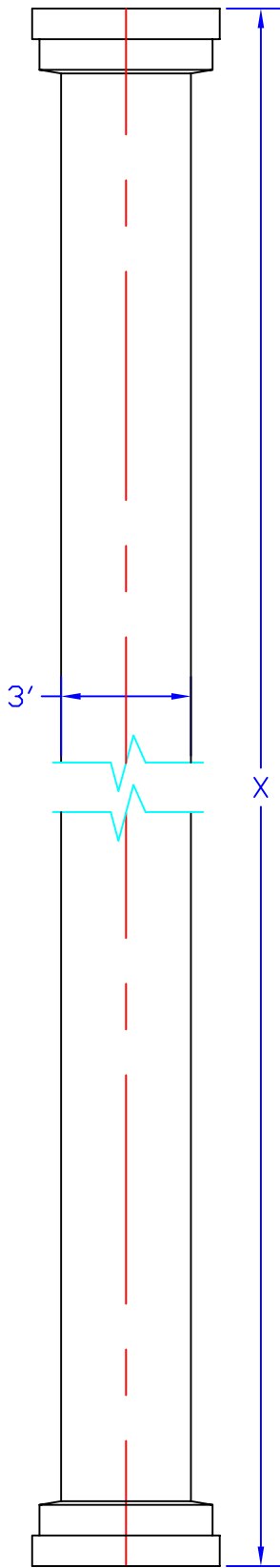

STAINLESS STEEL SCREW,
COUNTERSINK & FILL

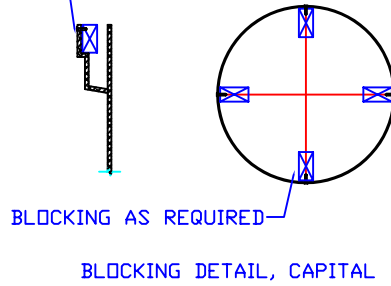

BLOCKING AS REQUIRED

BLOCKING DETAIL, CAPITAL

STAINLESS STEEL SCREW,
COUNTERSINK & FILL

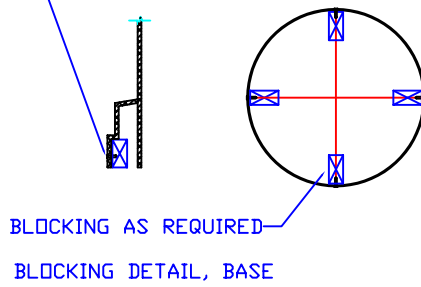

BLOCKING AS REQUIRED

BLOCKING DETAIL, BASE

CAPITAL & BASE
OPTIONAL
ALL COLUMNS SHIPPED
IN HALF-UNITS
COLUMN WILL FIT UP TO:
25" SQ. BEAM
Ø35" COLUMN

CLS36C

*FIBERGLASS
TECHNOLOGIES, INC.*

1610 Hanford St., Levittown, PA * (215) 943-4567 * FAX (215) 943-4540

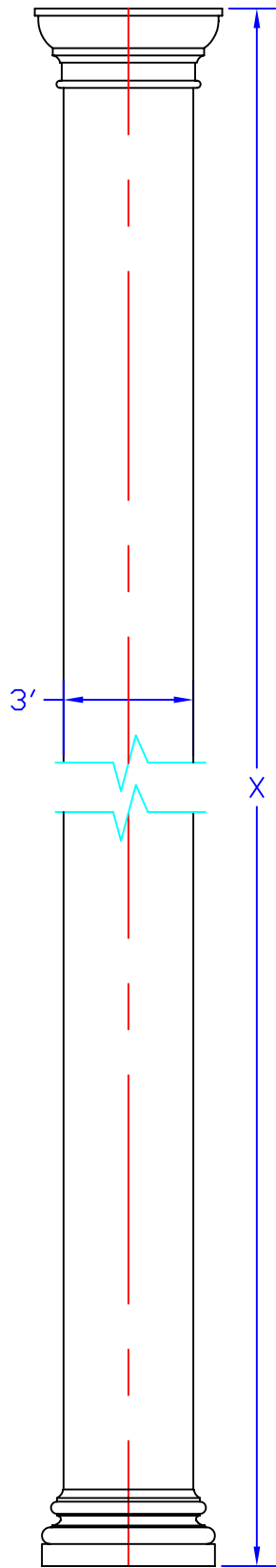

STAINLESS STEEL SCREW,
COUNTERSINK & FILL

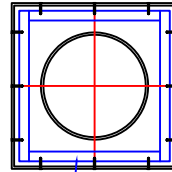

BLOCKING AS REQUIRED

BLOCKING DETAIL, CAPITAL

STAINLESS STEEL SCREW,
COUNTERSINK & FILL

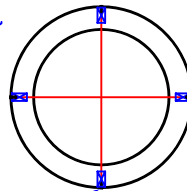

BLOCKING AS REQUIRED

BLOCKING DETAIL, BASE

CAPITAL & BASE
OPTIONAL
ALL COLUMNS SHIPPED
IN HALF-UNITS
COLUMN WILL FIT UP TO:
25" SQ. BEAM
Ø35" COLUMN

CLS36D

FIBERGLASS
TECHNOLOGIES, INC.

1610 Hanford St., Levittown, PA * (215) 943-4567 * FAX (215) 943-4540

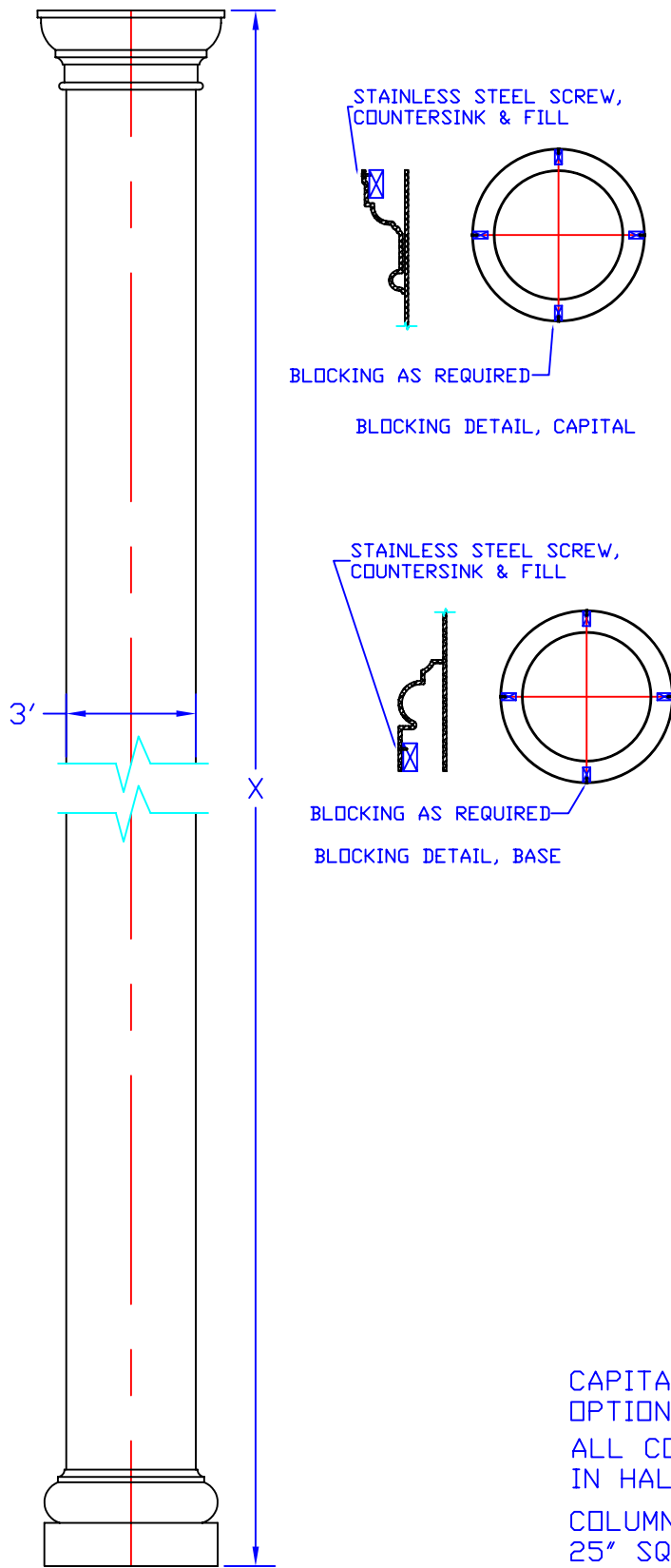

CAPITAL & BASE
OPTIONAL
ALL COLUMNS SHIPPED
IN HALF-UNITS
COLUMN WILL FIT UP TO:
25" SQ. BEAM
Ø35" COLUMN

CLS36E

*FIBERGLASS
TECHNOLOGIES, INC.*

1610 Hanford St., Levittown, PA * (215) 943-4567 * FAX (215) 943-4540