

CAPITAL & BASE  
OPTIONAL  
ALL COLUMNS SHIPPED  
IN HALF-UNITS  
COLUMN WILL FIT UP TO:  
9" SQ. BEAM  
Ø13" COLUMN

CLS14

*FIBERGLASS  
TECHNOLOGIES, INC.*

1610 Hanford St., Levittown, PA \* (215) 943-4567 \* FAX (215) 943-4540

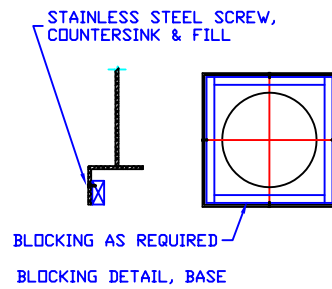
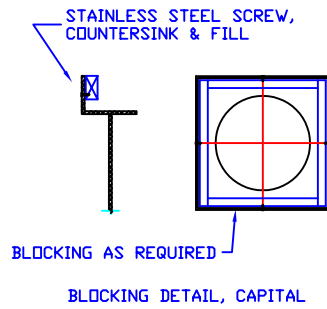
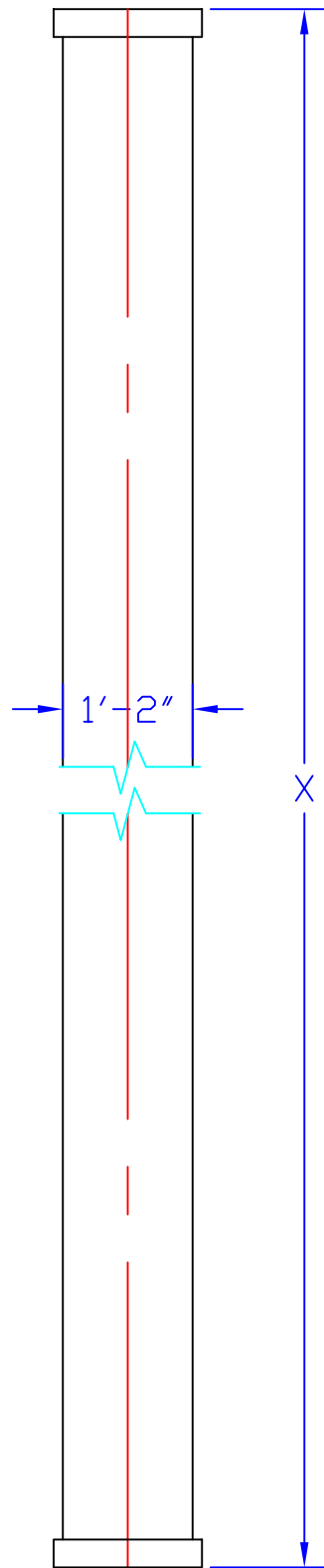

CAPITAL & BASE  
 OPTIONAL  
 ALL COLUMNS SHIPPED  
 IN HALF-UNITS  
 COLUMN WILL FIT UP TO:  
 9" SQ. BEAM  
 Ø13" COLUMN

CLS14A

*FIBERGLASS  
 TECHNOLOGIES, INC.*

1610 Hanford St., Levittown, PA \* (215) 943-4567 \* FAX (215) 943-4540

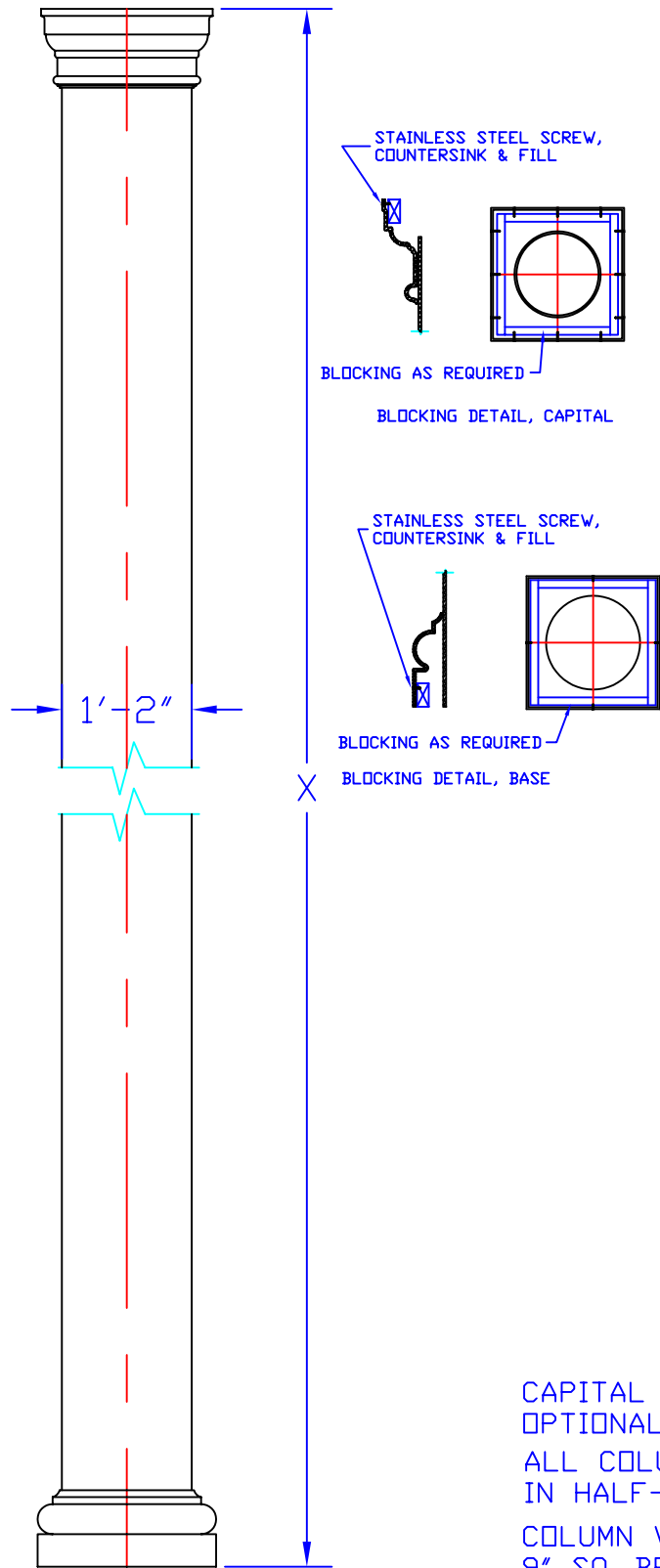

CAPITAL & BASE  
OPTIONAL  
ALL COLUMNS SHIPPED  
IN HALF-UNITS  
COLUMN WILL FIT UP TO:  
9" SQ. BEAM  
Ø13" COLUMN

CLS14B

*FIBERGLASS  
TECHNOLOGIES, INC.*

1610 Hanford St., Levittown, PA \* (215) 943-4567 \* FAX (215) 943-4540

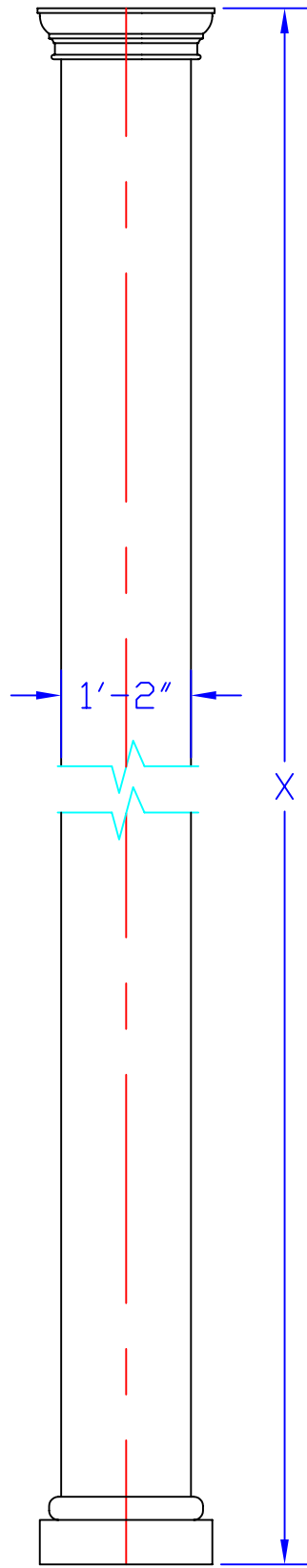

STAINLESS STEEL SCREW,  
COUNTERSINK & FILL

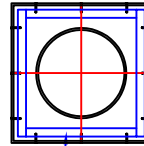

BLOCKING AS REQUIRED

BLOCKING DETAIL, CAPITAL

STAINLESS STEEL SCREW,  
COUNTERSINK & FILL

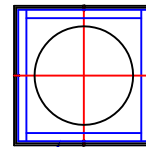

BLOCKING AS REQUIRED

BLOCKING DETAIL, BASE

CAPITAL & BASE  
OPTIONAL

ALL COLUMNS SHIPPED  
IN HALF-UNITS

COLUMN WILL FIT UP TO:  
9" SQ. BEAM  
Ø13" COLUMN

CLS14C

*FIBERGLASS  
TECHNOLOGIES, INC.*

1610 Hanford St., Levittown, PA \* (215) 943-4567 \* FAX (215) 943-4540

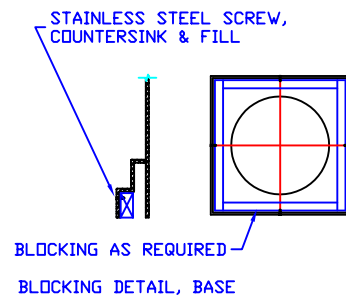
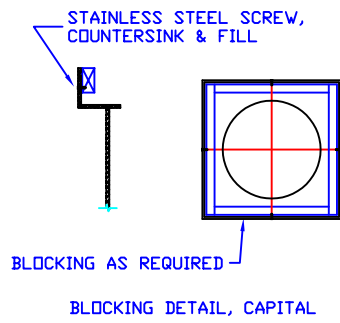
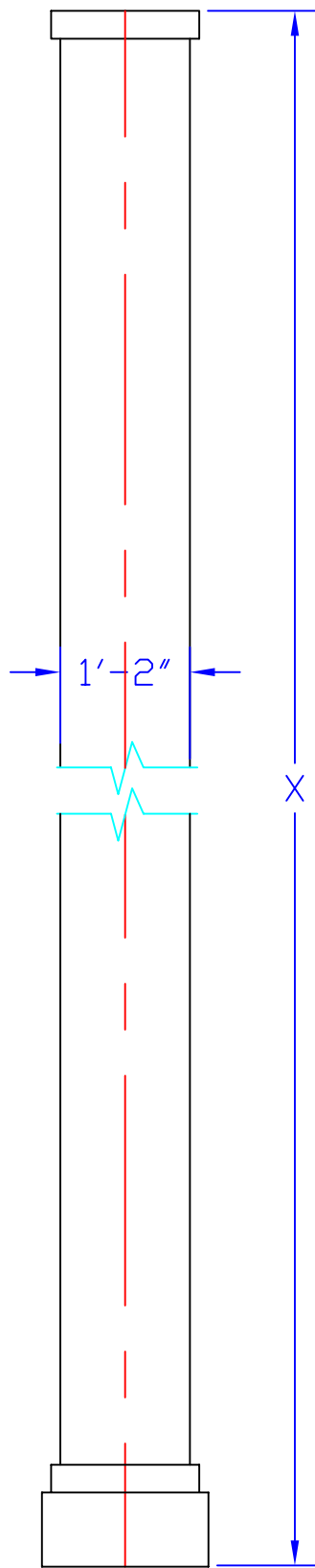

CAPITAL & BASE  
OPTIONAL  
ALL COLUMNS SHIPPED  
IN HALF-UNITS  
COLUMN WILL FIT UP TO:  
9" SQ. BEAM  
Ø13" COLUMN

CLS14D

*FIBERGLASS  
TECHNOLOGIES, INC.*

1610 Hanford St., Levittown, PA \* (215) 943-4567 \* FAX (215) 943-4540

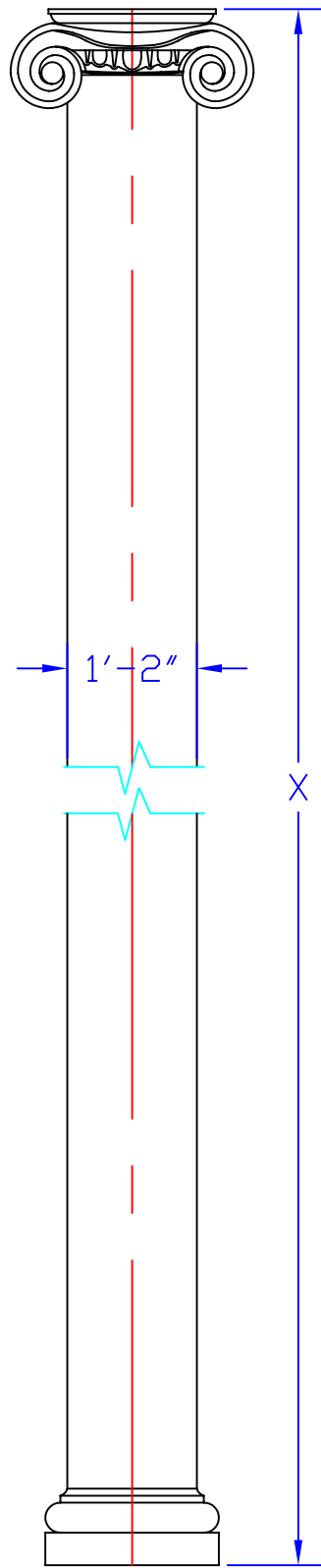

STAINLESS STEEL SCREW,  
COUNTERSINK & FILL  
CAUTION: DO NOT OVERTIGHTEN

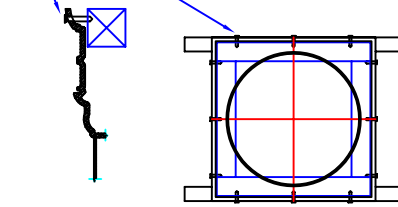

BLOCKING AS REQUIRED

BLOCKING DETAIL, CAPITAL

STAINLESS STEEL SCREW,  
COUNTERSINK & FILL

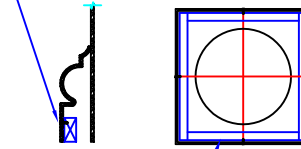

BLOCKING AS REQUIRED

BLOCKING DETAIL, BASE

CAPITAL & BASE  
OPTIONAL

ALL COLUMNS SHIPPED  
IN HALF-UNITS

COLUMN WILL FIT UP TO:  
9" SQ. BEAM  
Ø13" COLUMN

CLS14E

FIBERGLASS  
TECHNOLOGIES, INC.

1610 Hanford St., Levittown, PA \* (215) 943-4567 \* FAX (215) 943-4540

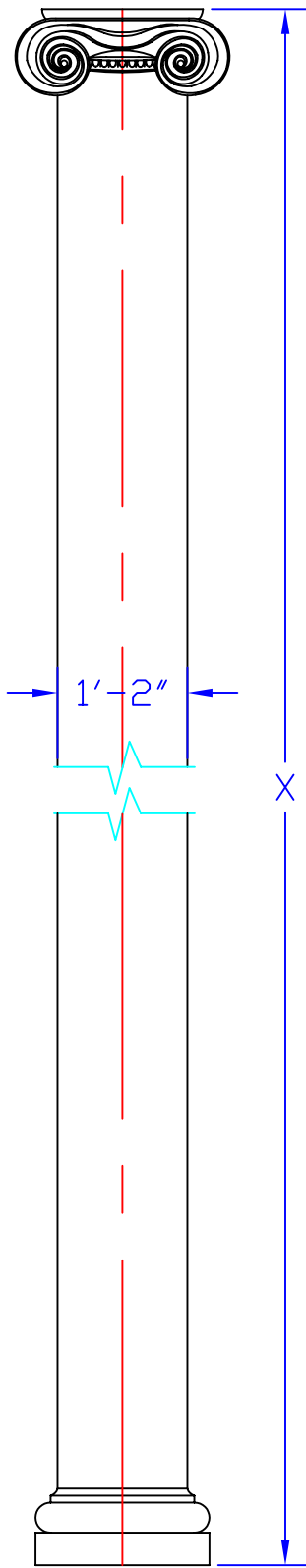

STAINLESS STEEL SCREW,  
COUNTERSINK & FILL  
CAUTION: DO NOT OVERTIGHTEN

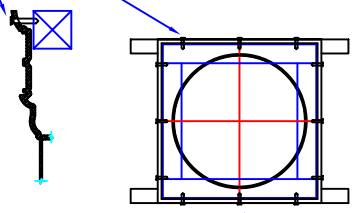

BLOCKING AS REQUIRED  
BLOCKING DETAIL, CAPITAL

STAINLESS STEEL SCREW,  
COUNTERSINK & FILL

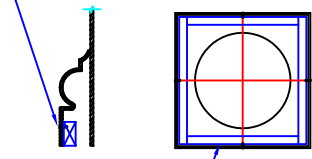

BLOCKING AS REQUIRED  
BLOCKING DETAIL, BASE

CAPITAL & BASE  
OPTIONAL  
ALL COLUMNS SHIPPED  
IN HALF-UNITS  
COLUMN WILL FIT UP TO:  
9" SQ. BEAM  
Ø13" COLUMN

CLS14F

FIBERGLASS  
TECHNOLOGIES, INC.

1610 Hanford St., Levittown, PA \* (215) 943-4567 \* FAX (215) 943-4540

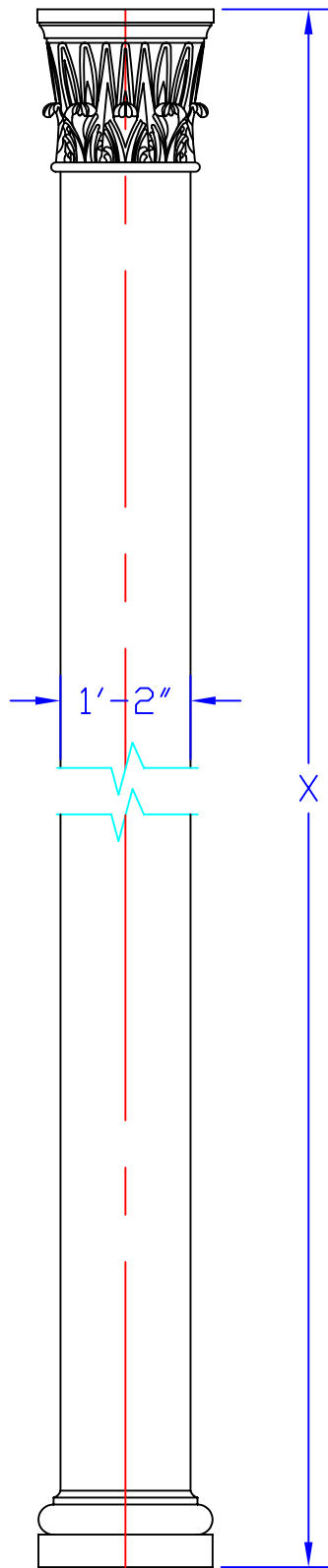

STAINLESS STEEL SCREW,  
COUNTERSINK & FILL

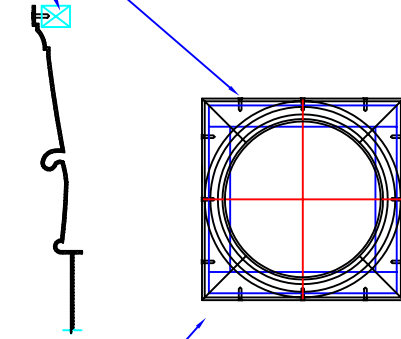

BLOCKING AS REQUIRED

BLOCKING DETAIL, CAPITAL

STAINLESS STEEL SCREW,  
COUNTERSINK & FILL

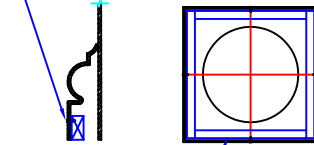

BLOCKING AS REQUIRED

BLOCKING DETAIL, BASE

CAPITAL & BASE  
OPTIONAL

ALL COLUMNS SHIPPED  
IN HALF-UNITS

COLUMN WILL FIT UP TO:  
9" SQ. BEAM  
Ø13" COLUMN

CLS14G

FIBERGLASS  
TECHNOLOGIES, INC.

1610 Hanford St., Levittown, PA \* (215) 943-4567 \* FAX (215) 943-4540