

BLOCKING DETAIL, CAPITAL

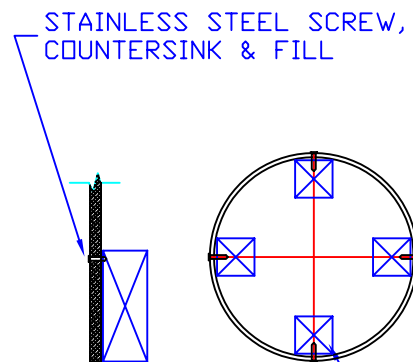

BLOCKING DETAIL, BASE

CAPITAL & BASE
OPTIONAL
ALL COLUMNS SHIPPED
IN HALF-UNITS
COLUMN WILL FIT UP TO:
15" SQ. BEAM
Ø21" COLUMN

*

CLM11

FIBERGLASS
TECHNOLOGIES, INC.

1610 Hanford St., Levittown, PA * (215) 943-4567 * FAX (215) 943-4540